



Nobi Ceiling Light 2.1 Installation & Onboarding Manual



Thank you for choosing **Nobi**

This document provides the key information you need for a smooth installation of the **Nobi Ceiling Light 2.1**.

For step-by-step onboarding instructions, scan the QR code below:

<https://tinyurl.com/4w4p654h>



Table of contents

Preparation	3
Safety precautions	4
Pre-installation	5
Mounting the Nobi Power	6
Attaching the Nobi Light	7
Onboarding the Nobi Light	8
Warnings	10

Contact Nobi



General questions

Take a look at our frequently asked questions and answers:
nobi.life/frequently-asked-questions



Support

For technical support during installation, contact Nobi Support: support@nobi.life

Preparation

Contents:

BOX A

- Nobi Ceiling Light



Nobi
Ceiling Light

BOX B

- Nobi Power with 2 connectors
(Wago — UL listed)
- Ceiling Adapter
- 4 metric screws



Nobi
Power



Ceiling
Adapter



4 Metric
screws

Required tools (not included):

- Multimeter
- Pencil
- Hammer
- Screwdriver
- Power drill
- Cable cutter
- Ladder
- Spirit level
- If there is no ceiling box or ceiling adapter, use appropriate plugs and screws suitable for the ceiling material:
 - 4 plugs (3/16")
 - 4 screws (M4)
- Mobile device (for onboarding purposes)

Estimated installation time:

- Nobi Ceiling Light installation
— approximately 45 minutes
- Onboarding — approximately 5 minutes

Before you begin:

- **Read all safety precautions** before starting the installation.
- The use of this manual is **restricted to Nobi Customer Services, authorized Nobi resellers, and technically trained individuals** who have received official Nobi installation training.
- Always onboard the Nobi Pendant Light or Nobi Ceiling Light before the Nobita Light.
- Install a Nobi switch to control the Nobi Light. This will add 10 minutes to the installation time.

Safety precautions

Read the following safety precautions carefully before installing the Nobi Ceiling Light 2.1



- Familiarize yourself with this manual and the product before installation. Service is guaranteed until 5 years after the EOL of the product. The expected service life is 10 years.
- When installing the Nobi Light, be aware of the risk of electric shock.
- This product must be installed in accordance with the applicable installation code by a person familiar with the construction and operation of the product and the hazards involved.
- The Nobi Lights shall be installed in an electrical circuit that contains a circuit breaker with a minimum contact separation of 1/10".
- A surge protective device (SPD) must be installed upstream on each phase of the Nobi Light 2.1 as part of the building installation.
- The SPD (rated up to 2500 V peak) must comply with EN/IEC 61643-11.
- The Nobi Light is for indoor use only.
- The Nobi Light shall not be mounted inside a closet.
- The Nobi Light shall not be installed in a bathroom or restroom.
- The Nobi Lights must be mounted on the ceiling.
- The Nobi Light is designed to support a maximum static load of 11 lbs / 5 kg. Under no circumstances shall the Nobi light be subjected to a load exceeding this stated limitation.
- The light source in this Nobi Light should only be replaced by Nobi, Nobi's service agent or a similarly qualified person.
- Install the Nobi Light out of arm's reach.
- Service may only be performed by the manufacturer or its service agent.
- Once installed, the equipment is not intended for direct physical contact by any person.

Installing the Nobi Light



Pre-installation

- 1** **Locate the main circuit breaker box and switch off the electrical power.**
To cut off power to individual rooms or circuits, switch the branch fuse to the OFF position.

Use a multimeter (or a known connected switch) to **verify** that the **power is fully disconnected**.

- 2** **Remove the current light fixture (if present), exposing 3 electrical wires:** ground (green or bare), neutral (white), and switched hot (black).
Make sure you can identify each wire correctly. The colors may vary by country or local regulations. Tape or cap any unused ground wires.

Notice: The switched line must be bridged to the live line behind the switch controlling the lighting point where the Nobi Light will be installed, ensuring the lighting point has constant mains voltage (100 V-240 V).

- 3** Take the Nobi Power out of the box.

Mounting the Nobi Power

4

- If a **CEILING BOX (US)** is **PRESENT** or an existing light is replaced: **Connect the ceiling adapter to the ceiling box** using the 2 screws provided with the ceiling box.
- If **NO CEILING BOX** is **PRESENT**, or if you are installing a new light: **Mark the 4 drill holes** with a pencil by holding the Nobi Power against the ceiling.

Drill the holes to the appropriate depth using a 15/64" (6.0 mm) drill bit at the marked points.

Carefully **tap the plugs** into the drilled holes.

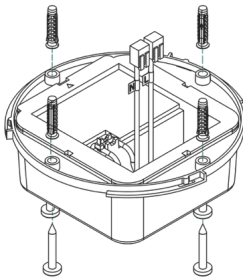

Precise marking is critical to the accuracy and ease of the subsequent steps.

5

Hold the Nobi Power against the ceiling near the outgoing electrical wires.

6

Connect the electrical wires to the Nobi Power by using the 2 connectors. Connect the switched hot (black) wire and the neutral wire (white) to the appropriate wires on the Nobi Power. Do not connect them to the same connector. The ground wire (green or bare) should not be connected. Tape or cap any unused ground wires.

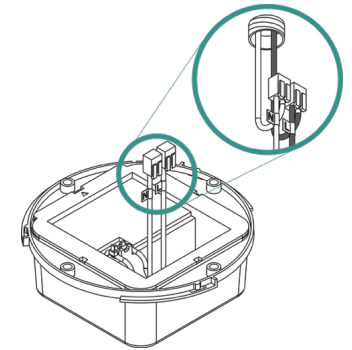

7

Mount the Nobi Power with the four screws.

- If a **CEILING BOX (US)** is **PRESENT** or an existing light is replaced: Use the 4 included metric screws.
- If **NO CEILING BOX** is **PRESENT** or a new light is being installed: Use 4 screws that are applicable to the ceiling material being used.

Tighten the screws, ensuring the Nobi Power is firmly fixed to the ceiling. Use all 4 screws for a sturdy installation.

8

Switch the fuse back on.

A small green light on the Nobi Power will illuminate.

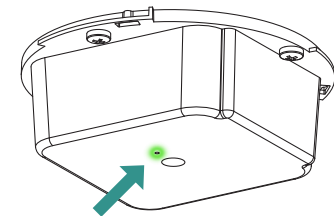

Attaching the Nobi Light

9 **Plug the Power Cable** from the Nobi Light into the Nobi Power.

10 Position the light over the Nobi Power and turn 90° to the right until you hear/feel a soft clicking sound.

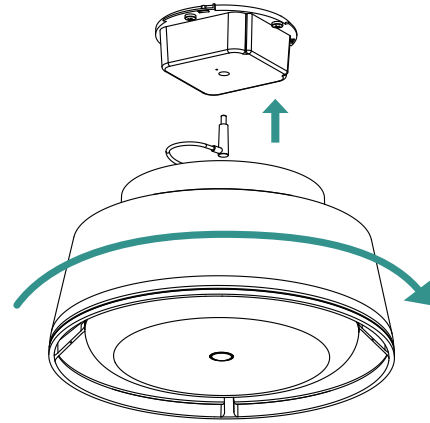

11 The Nobi Light will first flicker white, then show a yellowish color and finally flash blue.

12 **Remove the protective plastic** located on the underside of the Nobi Light. You are ready to start onboarding.

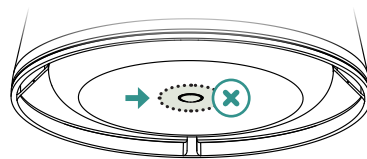

Onboarding the Nobi Light



Before beginning the onboarding process:

1. **Contact your local distributor or Nobi**, as your account must be created before onboarding can begin.
2. **Download the app:**



Onboarding the Nobi Light

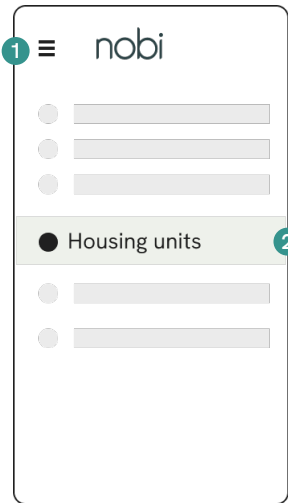

- 1 Open the **navigation menu** by clicking on the 3 lines in the top-left corner.
- 2 Go to **Housing units** in the navigation menu.

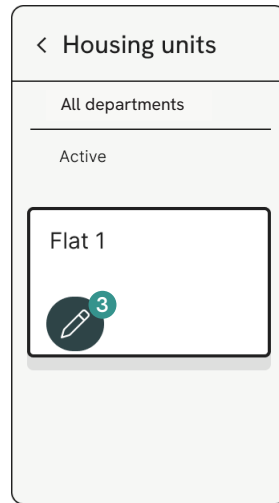

- 3 Click on the **Edit** button for the housing unit in which you installed the Nobi Light.

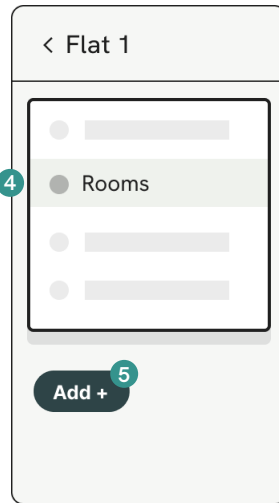

- 4 Select the **Rooms** tab.
- 5 Click on the **Add** button.

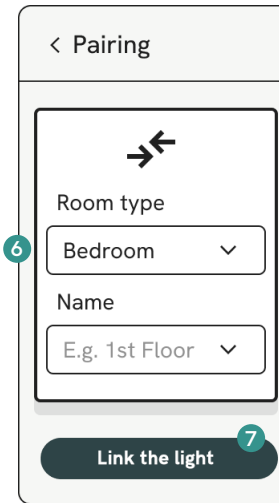

- 6 Select the **type of room**, for example bedroom or living room. Name the room if more than one identical type of room is used.
- 7 To proceed click on the **Link the Light** button.

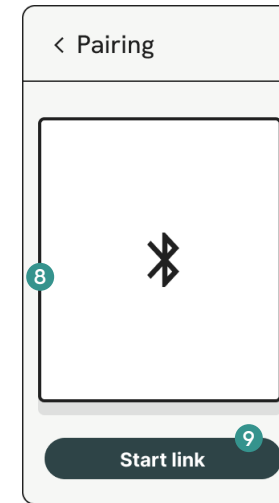

- 8 Make sure that:
 - **Bluetooth** is enabled on your mobile device;
 - that you are in the same room as the Nobi Light;
 - and that the Nobi Light is flashing blue.
- 9 If all the above are met, click on the **Start link** button.

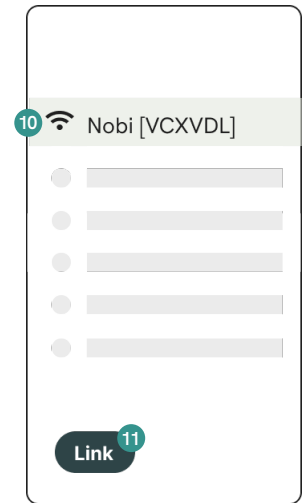

- 10 **Choose the correct Nobi Light** from the list of available Nobi Lights, based on the secure code shown on the sticker of the Nobi Light. This code consists of six characters.
- 11 Click on the **Link** button.
The pairing process will start automatically. At the end, you will receive confirmation that the light is successfully paired.





















After the onboarding:

An update may occur; its duration depends on your WiFi network's capacity. This update occurs in the background and may impact the availability of new features.

Warnings for the Nobi Light

Symbols

	Consult manual before use		Do not stare at the light source		FCC marking		Recycling
	Caution, risk of electric shock		Ceiling mount use only		CE marking		Warning sign
	Class II		Emits IR light		UK Conformity Assessed		Read manual before use
	Class III		Indoor use only		Location of manufacturing		DC polarity
 		Caution is needed when installing and using this device; consult the manual before use					

Environmental conditions

- Operating temperature: 50 °F to 104 °F / 20 °C to 40 °C
- Operating humidity: 15% to 95% RH (non-condensing)
- Atmospheric pressure: 9.6 to 15.4 psi / 66 kPa to 106 kPa and maximum 6560 ft or 2000 m altitude

Technical specifications

Nobi Ceiling Light 2.1

Input

- 24 V DC
- Max 2.20 A
- Max 56 W
- Pf = 0.41 (EU)
- Pf = 0.54 (UL)

Nobi Power 2.1

Input

- 100-120 V AC (UL)
- 220-240 V AC (EU)
- 50/60 Hz
- Max 1.7 A

Output

- 24 V DC
- Max 2.2 A

Labels

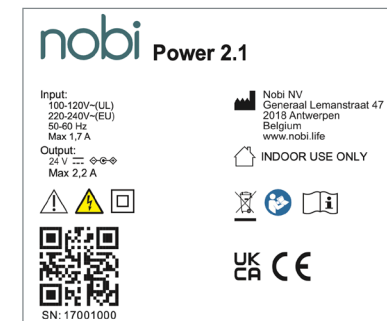

Disposal message

Your product is designed and manufactured with high-quality materials and components, which can be recycled and reused. Please find out for yourself about the local separate collection system for electrical and electronic products. Please follow your local regulations and do not dispose of this product with regular household waste. The correct disposal of your old product will help prevent potential negative consequences for the environment and human health.